

# QUICK INSTALLATION GUIDE

# MAX APP BASED CELL KEYPAD

RESIDENTIAL / COMMERCIAL APPLICATION







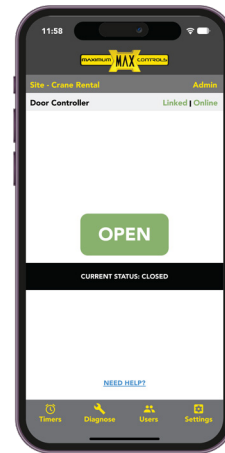

**APP CELL BASED KEYPAD**

**Max Cloud App**



## **Key Features**

-  **App Based Trackable Keypad**
-  **Affordable cell data plans (AT&T or Verizon)**
-  **16 Zone Control using Wiegand Converters**
-  **15 Wireless zone control (1 mile range / 900 MHz) (with wireless Wiegand Converters)**
-  **Push Notification for "Call" button pressed or Visitor Motion Detected **COMING SOON****
-  **Guest Pass with date and time restriction**
-  **Event Log of all transactions**



# Max Keypad

Overview .....	3
Entry gate application .....	4
Pedestrian door application .....	6
Setting up Max Cloud App .....	7
Setup a new gate site with App .....	8
Program Keypad greetings message.....	9
Program Keypad call button message .....	10
Add a new user on App .....	11
Program keycodes with restrictive times .....	12
Program timers .....	13
Cell date activation setup .....	14

## APP BASED CELL KEYPAD

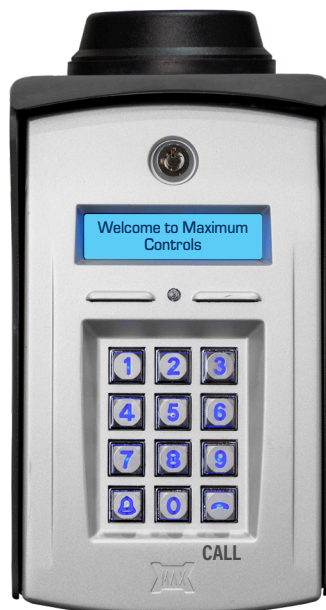

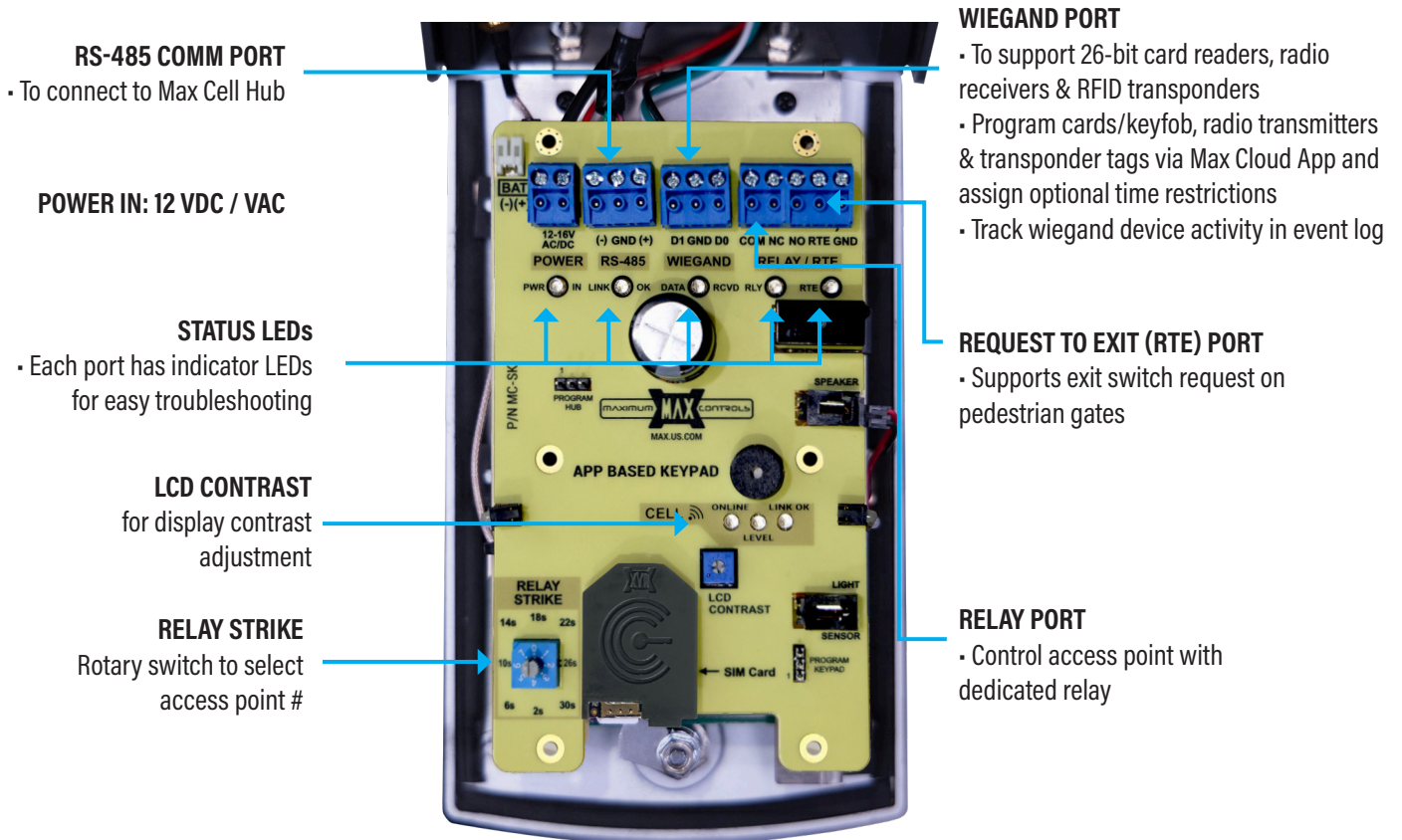



# ENTRY GATE APPLICATION USING APP BASED KEYPAD

APP BASED KEYPAD

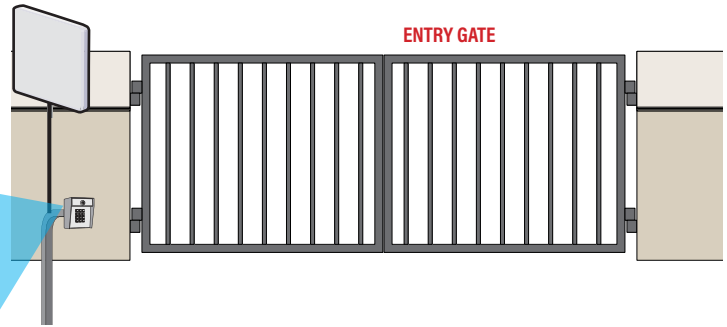

ENTRY GATE

## 4 Wiring Transponder Device

Install transponder device as shown

## 1 Wiring Power Input

Connect 12VDC, 1A power transformer to **Power Input** port of Max Keypad (polarity does NOT matter)

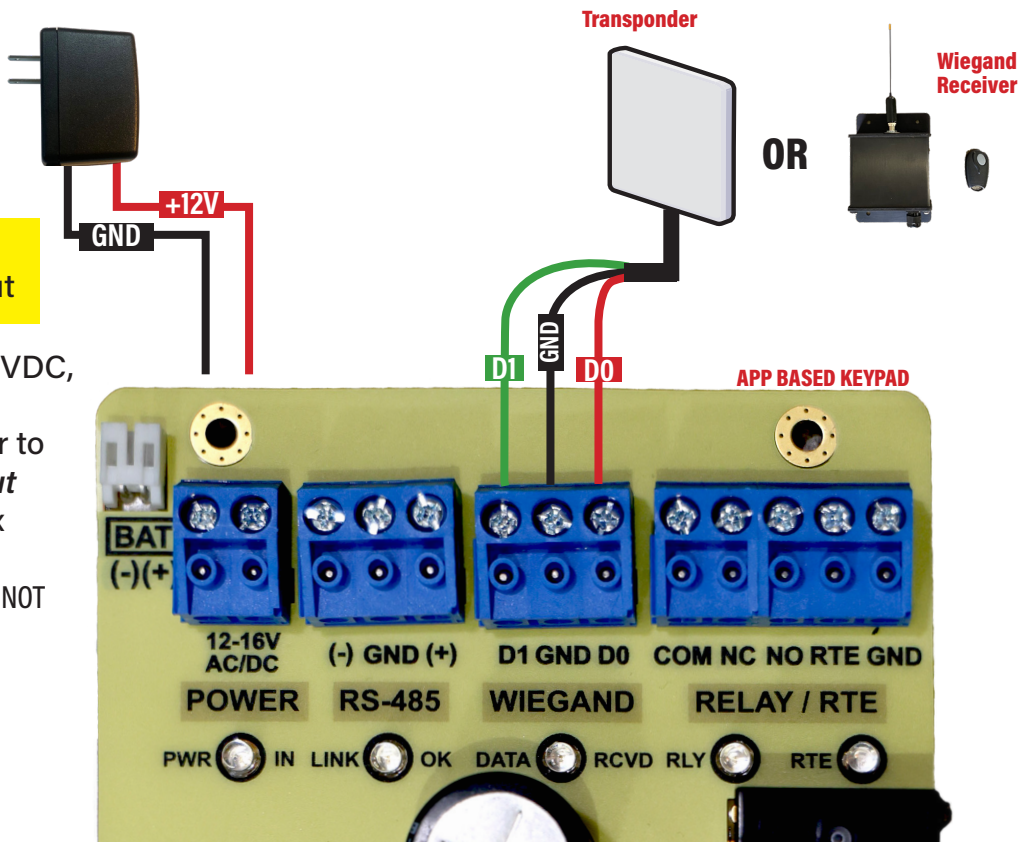

## 2 Select "RELAY STRIKE" using rotary switch

Select #0: to open gate via *Cell Hub* (note: keypad relay NOT activated)

Select #15: to open gate via *Cell Hub* (note: keypad relay is also activated)

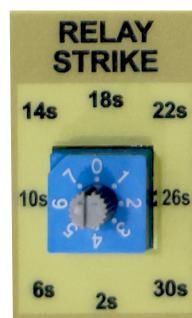

**2** Wiring Solenoid Lock

Install Solenoid Lock as shown below

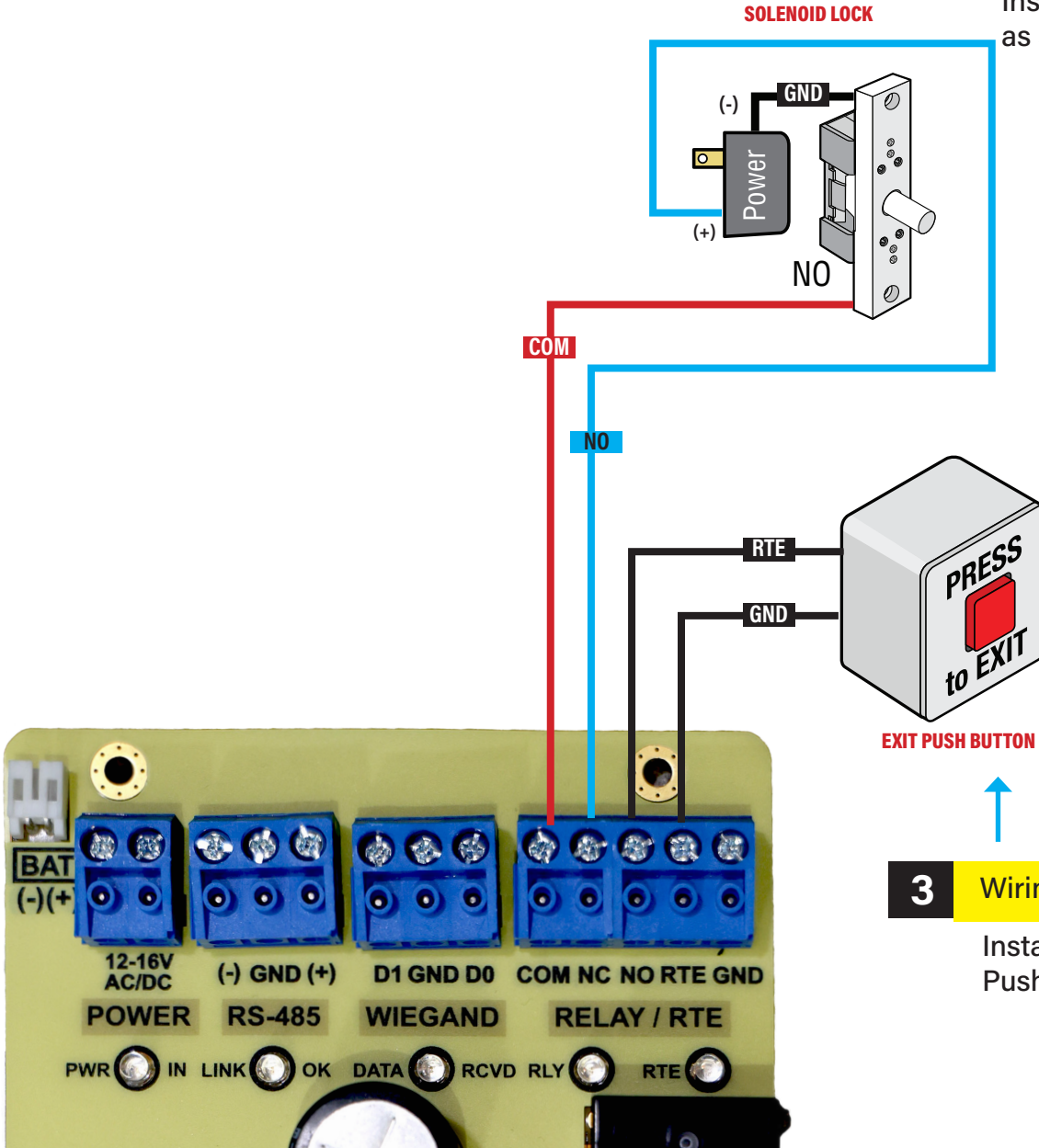

**3** Wiring Exit Push Button

Install request to Exit Push Button as shown

**4** Select "Realy Strike Tlme" using rotary switch

Select #2s-30s: to open gate using *Relay Strike*



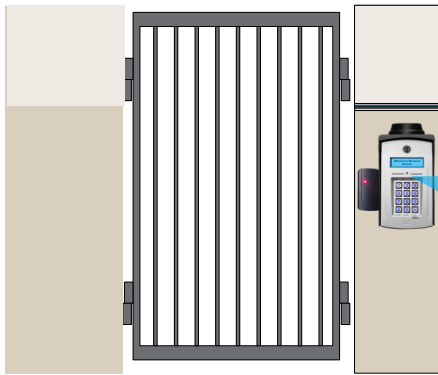

App Based Keypad



1 Wiring Power Input

Connect 12VDC, 1A power transformer to *Power Input* port of Max Keypad (polarity does NOT matter)

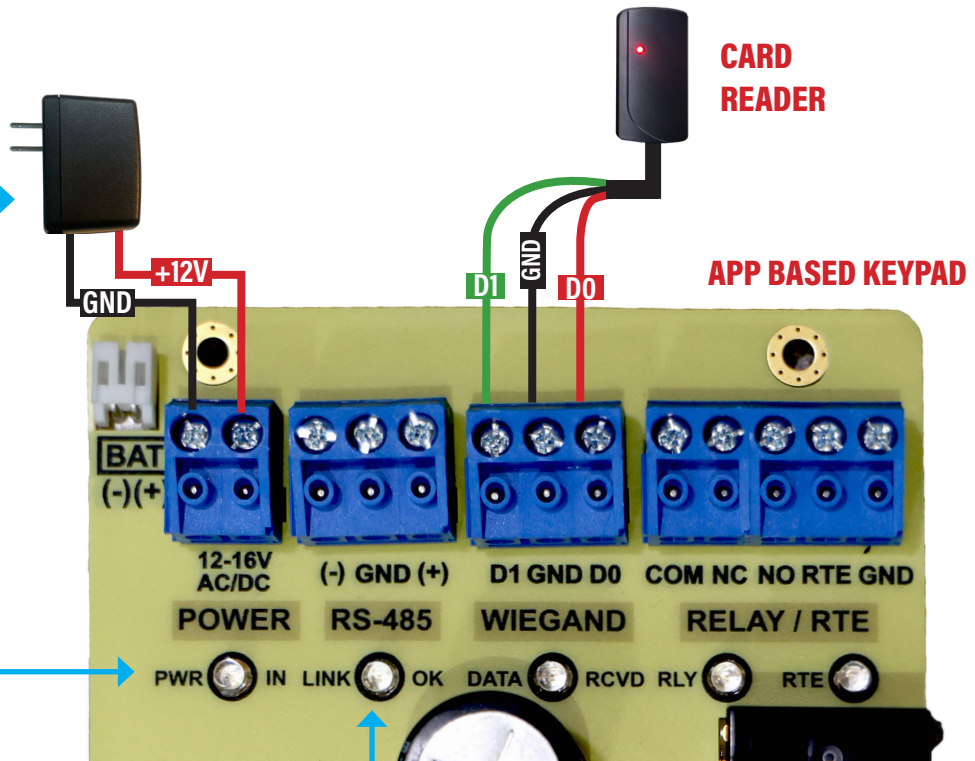

Verify POWER LED is ON

Verify RS-485 LED turns ON otherwise revise your wiring

**1** Getting Max Cloud App

Max Cloud App is available for download on:



**2** How to install Max Cloud App on **android phones**

1. Open the **Google Play Store** App in your phone.

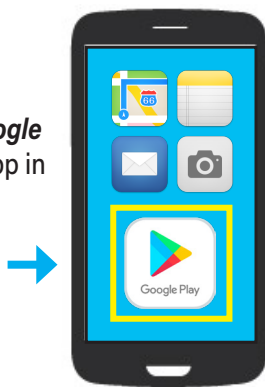

2. Type Max Cloud App in the search bar
3. Tap the Install button.

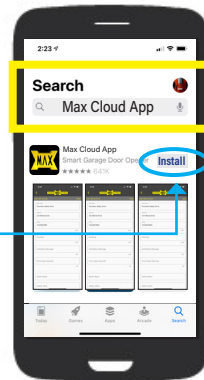

4. Confirm the installation
5. Open Max Cloud App by clicking Max Cloud app icon

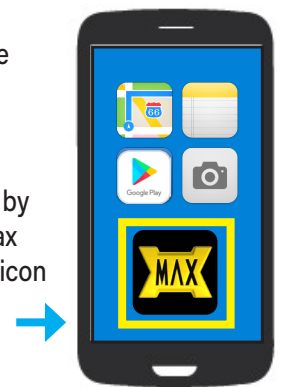

**2.1** How to install Max Cloud App on **iphone**

1. Open the **App Store** in your iphone.

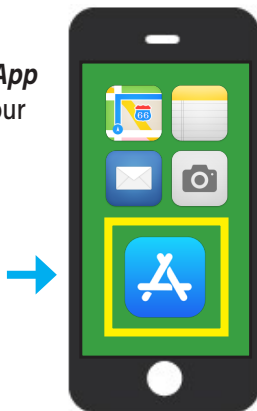

2. Type **Max Cloud App** in the search
3. The app will be shown below the search bar, press **GET** to download

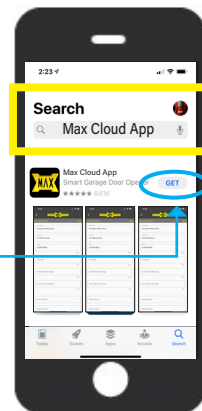

Confirm the installation

Open Max Cloud App by clicking the Max Cloud App Icon



**3** Max Cloud Login for the first time

1. Open the **Max Cloud app** in your phone.
2. Add a phone number then press **Login**.  
*Android phone does automatic verification*



3. On **iphone** phone Max Cloud app will send you a code to verify your account. Enter the code and press **verify**, now you Max Cloud app is now ready.

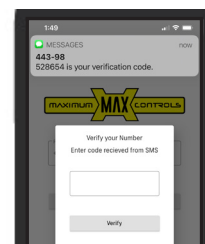

## 1 Add a New Gate Site on App

Click on + **Add a Gate** icon in app

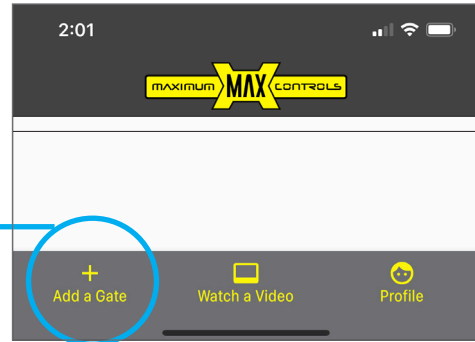

## 2 Setup gate site info

a.- Enter a site name

b.- Enter the IMEI# of the App Based Keypad



IMEI# is located on the inside of Max App Based Keypad

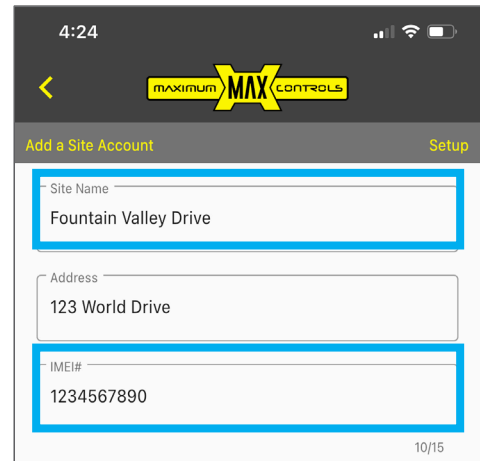

**⚠ Please double check your entry to ensure cell connectivity**

## 3 Set up ADMIN for the gate site

Add the name and cell # of the person who will manage the gate site

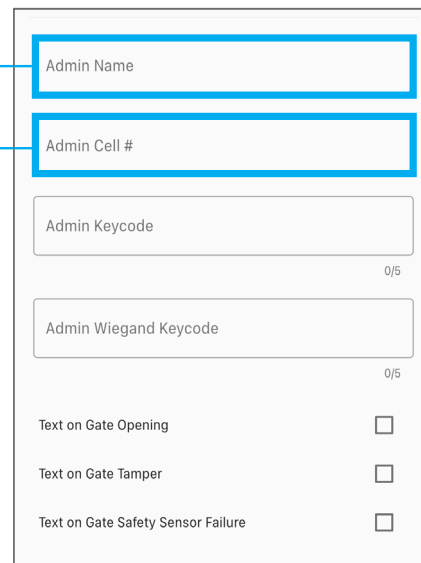

## 4 OPTIONAL Choose alert notifications

For manager to receive text alert for real time events

## 5 EXIT & SAVE changes

Press the **back button** [**<**] on the top left of the screen to confirm changes

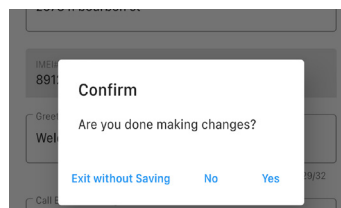

## 6 Choose the new site from the list

**1** Press **Settings** icon in the main menu

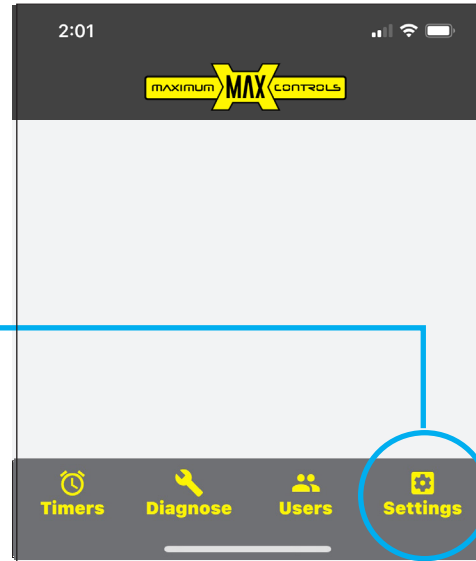

**2** Setup greeting message

Go to the **GREETING** area and type the message you want to display for your visitors. Limited to 32 characters.

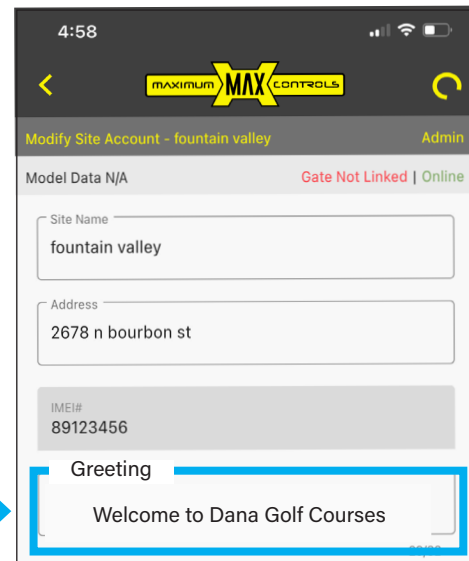

**1** Setup Call Button

Go to the **Call Button** area and type the message that may instruct the visitor to call a specific phone number (i.e. facility manager or home owner) using their personal cell phone.  
**Example CALL** button message: **"CALL (949) 000-0000 on your phone"**



When CALL button is pressed, display shows programmed message

CALL Button

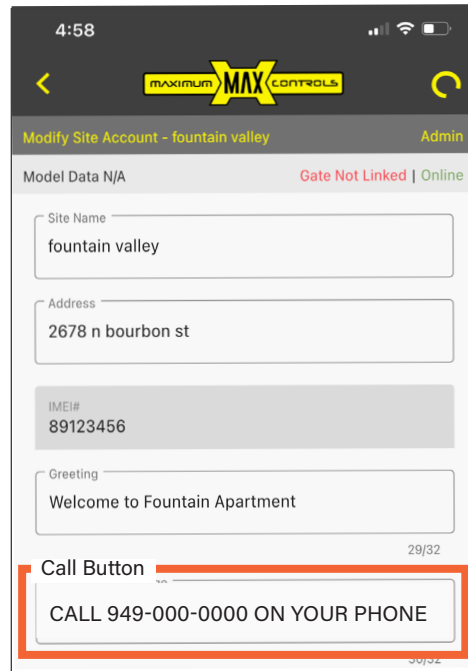

**2** Press the **back button** [ < ] on the top left of the screen to confirm changes

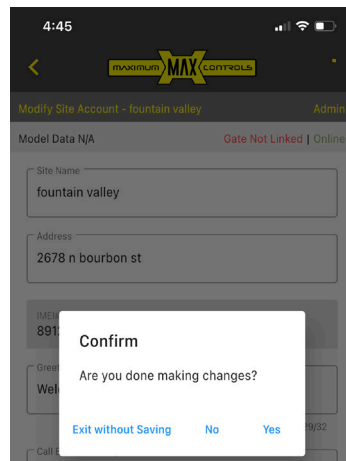

**1** Press **Users** icon in the main menu

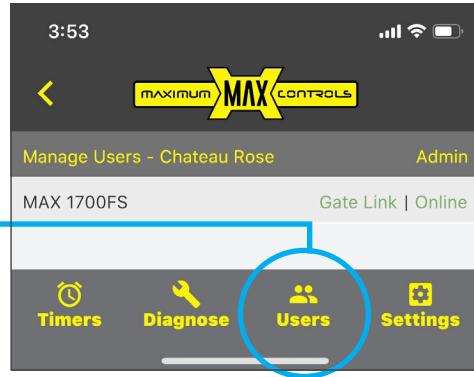

**2** Then Press **Add a User** in the following menu

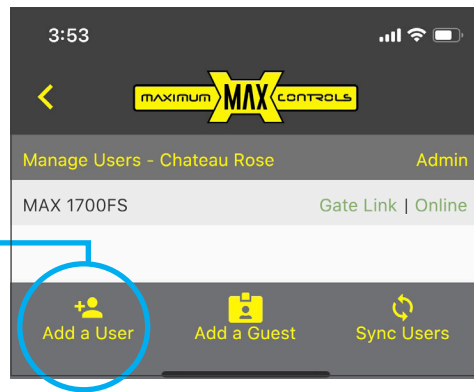

**3** Enter **Name** of your visitor, then assign a **5 digit keycode**

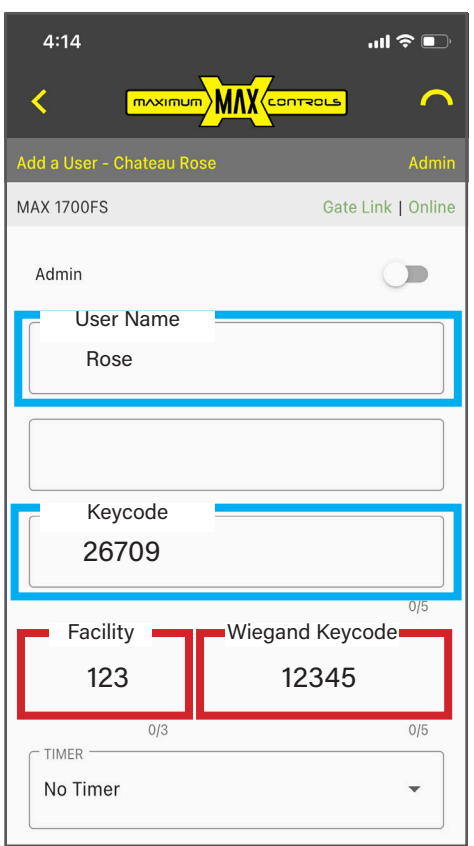

**4** Program Wiegand Keycode  
If a Wiegand device is wired to keypad wiegand port then enter **Facility and Wiegand Keycode for the transmitter, keyfob or tag**

**5 Assign a timer (OPTIONAL)**

Choose one of six timer schedules

These time restrictions apply to both keycode and Wiegand keycode

If you choose No Timer  
Keycode has no time restriction

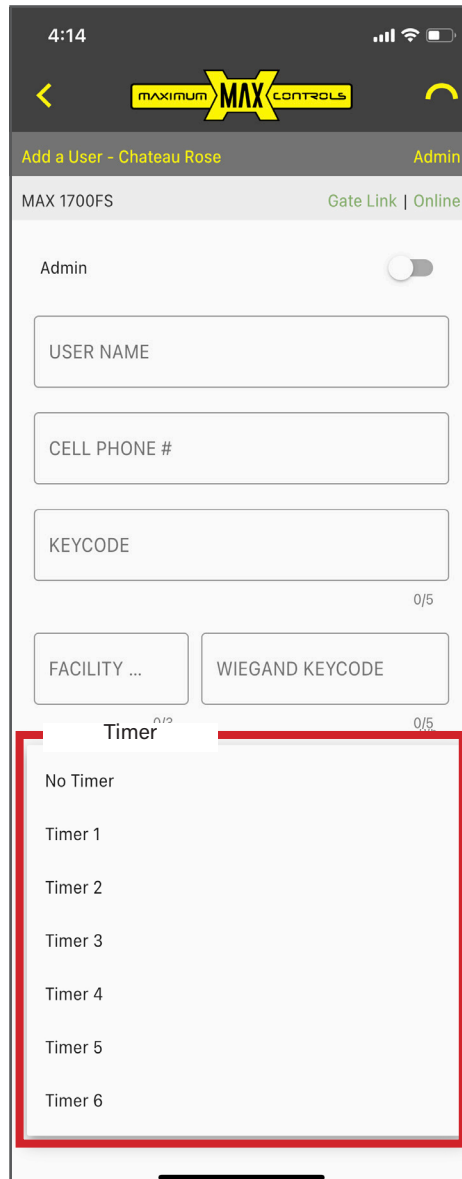

**6 Press the *back button* [<] on the top left of the screen to confirm create a user**

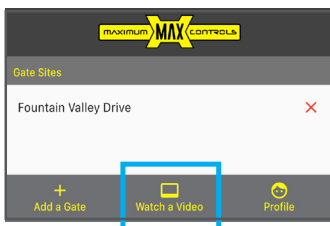

Watch video tutorials from Max Cloud App, just go to the home screen

OR

**SCAN CODE**  
to watch tutorial



Applying restrictive time period to keycodes improves the security to your gate site

**1** Press *Timers* icon in the main menu

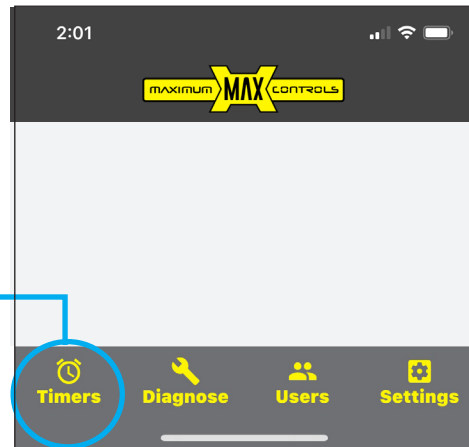

**2** Choose the *Timer* option you want to setup from the list of timers

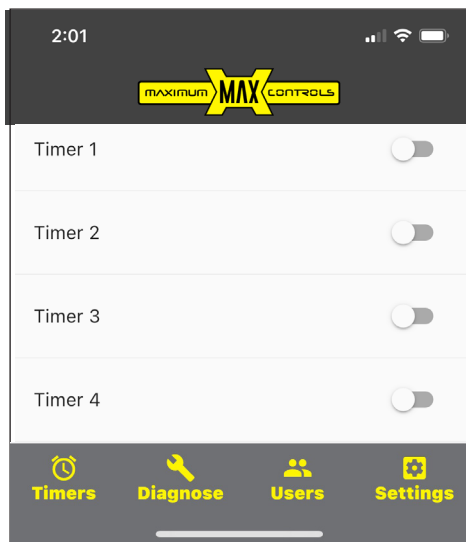

**2** Choose the *Timer* option you want to setup from the list of timers

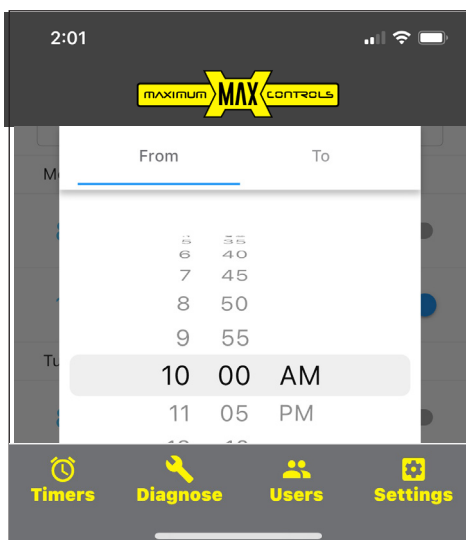
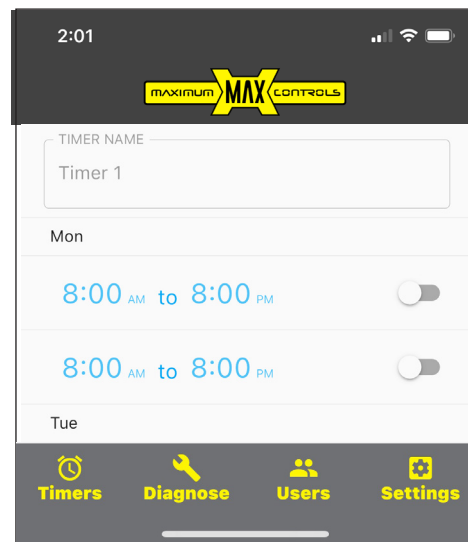

## SCAN QR CODE TO:

Activate HUB's SIM card at  
[www.Max.us.com/products-cell-data-activation](http://www.Max.us.com/products-cell-data-activation)



**1** Go to <https://max.us.com>

**2** Press Max App on the main menu

Select **Max App Overview** then select and click on **Cell Data Activation**

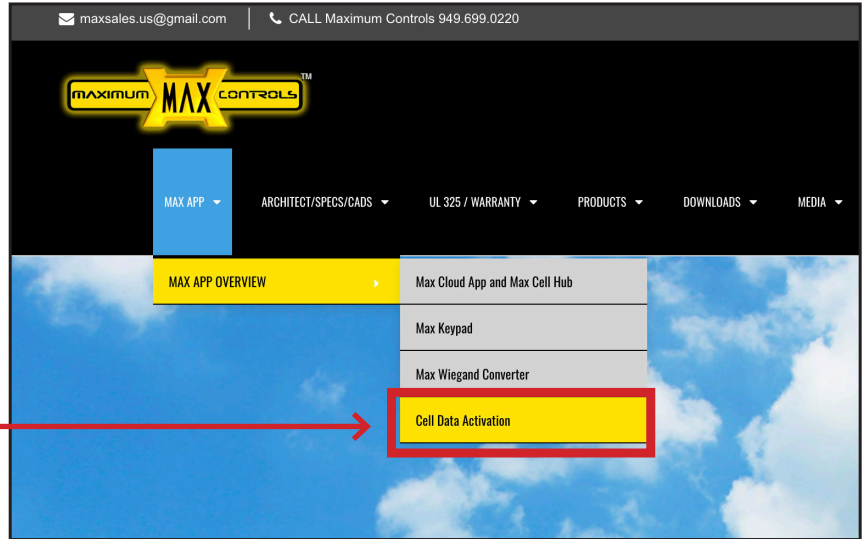

**3** Start watching the video tutorial

**4** Go to **Cell Data Activation** Button

Will take you to our secure portal  
<https://www.iotactivate.com/>  
 to fill important information to register your account

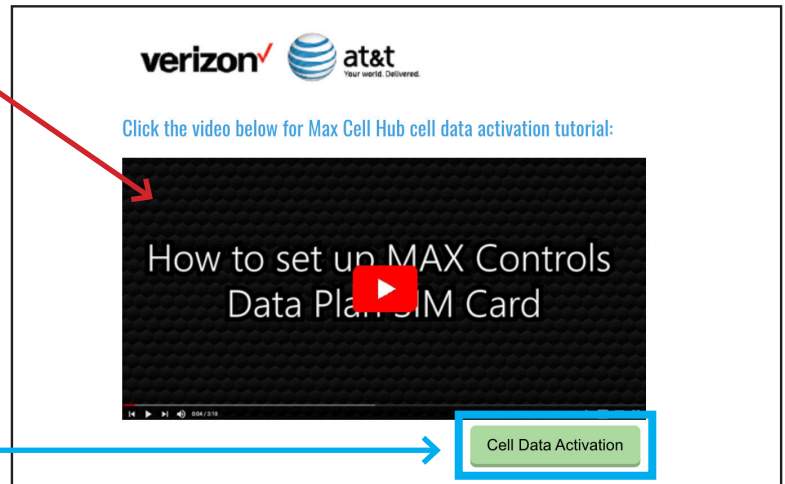

Please have in hand the SIM Card (AT&T or Verizon) provided with Max App Based Keypad and IMEI#

Please double check your entry to ensure cell connectivity

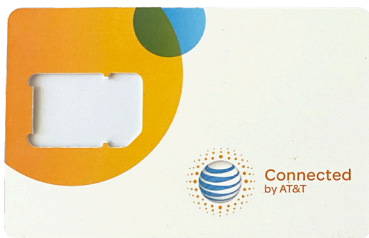

IMEI# is located on the inside of Max App Based Keypad

**5** Setting up account information

- a.- Under Marketplace subscription plans choose as a provider **Maximum Controls**
- b.- Choose a subscription Plan
- c.- Follow instructions on the site to complete set up your account information and submit

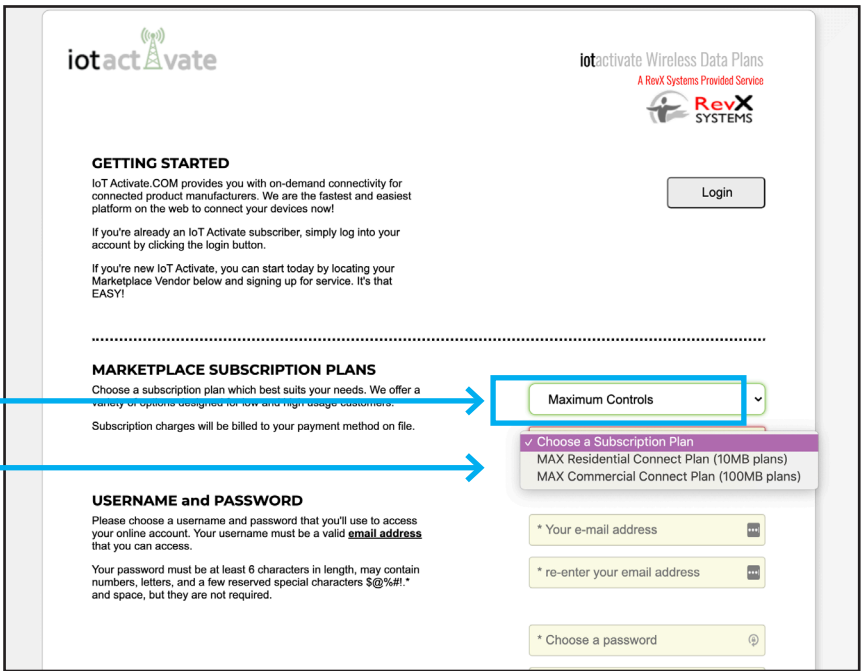

**6** Enter your login info

Will take you to our secure portal <https://www.iotactivate.com>, enter username and password then press login

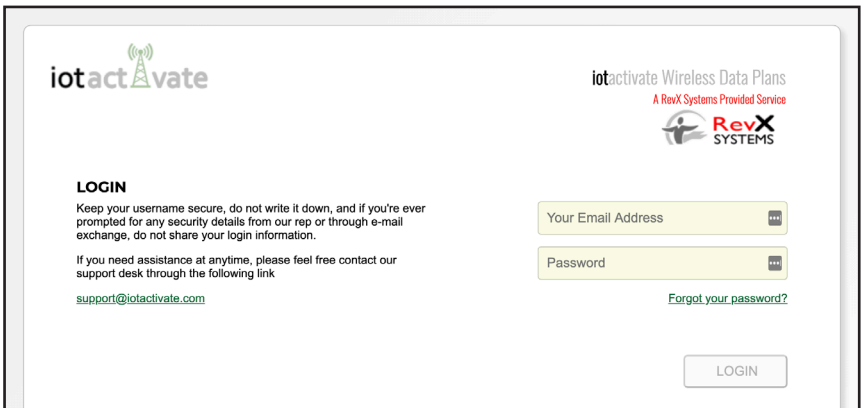

**7** Review SUBSCRIPTIONS

Review your data plan shown in the your Active Subscription Plans section

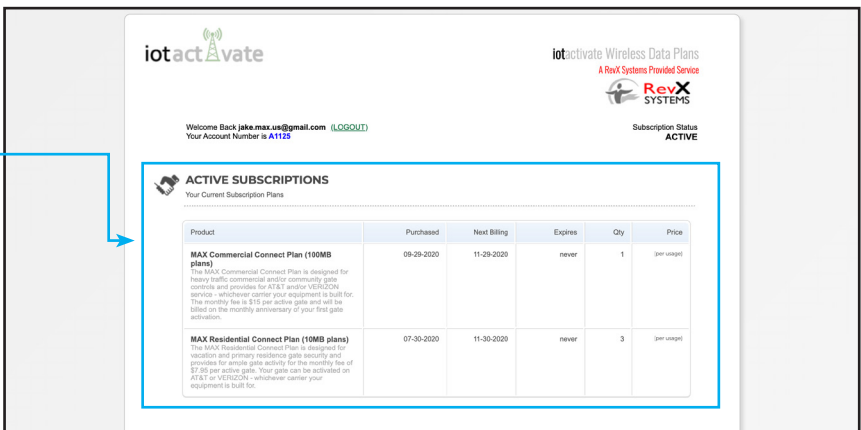

## 8 Activate SIM card

a.- Go to *My Services and Equipment* and *click over the plan and provider* you want to connect

b.- Go to *Activate a new subscription*

▶ MAX COMMERCIAL (VERIZON) \$15.00 MONTHLY - 1 LINE(s)

**MAX RESIDENTIAL CONNECT PLAN (10MB PLANS)**  
The MAX Residential Connect Plan is designed for vacation and primary residence gate security and provides for ample gate activity for the monthly fee of \$7.95 per active gate. Your gate can be activated on AT&T or VERIZON - whichever carrier your equipment is built for.

▼ MAX RESIDENTIAL (AT&T) \$7.95 MONTHLY - 2 LINE(s)

ICCID (AT&T)	IMEI (AT&T)	START DATE	STATUS	NICKNAME

ACTIVATE A NEW **MAX RESIDENTIAL (AT&T) \$7.95 MONTHLY** SUBSCRIPTION HERE

ICCID (at&t) IMEI (at&t) **ACTIVATE**

\* NOTE: Your activation is usually complete within 2-5 minutes.

c.- Enter the *ICCID* information located on the back of the SIM Card provided



d.- Enter the *IMEI#* that is ocated on the inside of Max App Based



  
Please double check your entry to ensure cell connectivity

d.- Press **ACTIVATE** button

▶ MAX COMMERCIAL (VERIZON) \$15.00 MONTHLY - 1 LINE(s)

**MAX RESIDENTIAL CONNECT PLAN (10MB PLANS)**  
The MAX Residential Connect Plan is designed for vacation and primary residence gate security and provides for ample gate activity for the monthly fee of \$7.95 per active gate. Your gate can be activated on AT&T or VERIZON - whichever carrier your equipment is built for.

▼ MAX RESIDENTIAL (AT&T) \$7.95 MONTHLY - 2 LINE(s)

ICCID (AT&T)	IMEI (AT&T)	START DATE	STATUS	NICKNAME

ACTIVATE A NEW **MAX RESIDENTIAL (AT&T) \$7.95 MONTHLY** SUBSCRIPTION HERE

678U99563 352753093240685 **ACTIVATE**

\* NOTE: Your activation is usually complete within 2-5 minutes.

e.- Review the status of your device; should show **ACTIVE**. In the event that shows **PENDING**, refresh your browser

▶ MAX COMMERCIAL (VERIZON) \$15.00 MONTHLY - 1 LINE(s)

**MAX RESIDENTIAL CONNECT PLAN (10MB PLANS)**  
The MAX Residential Connect Plan is designed for vacation and primary residence gate security and provides for ample gate activity for the monthly fee of \$7.95 per active gate. Your gate can be activated on AT&T or VERIZON - whichever carrier your equipment is built for.

▼ MAX RESIDENTIAL (AT&T) \$7.95 MONTHLY - 2 LINE(s)

ICCID (AT&T)	IMEI (AT&T)	START DATE	STATUS	NICKNAME
89011703278374704081	359215100545533	07/30/2020	<b>ACTIVE</b>	JAKE ATT #1

f.- Now your device is ready. Please **LOGOUT** on the top of the website



# QUICK INSTALLATION GUIDE





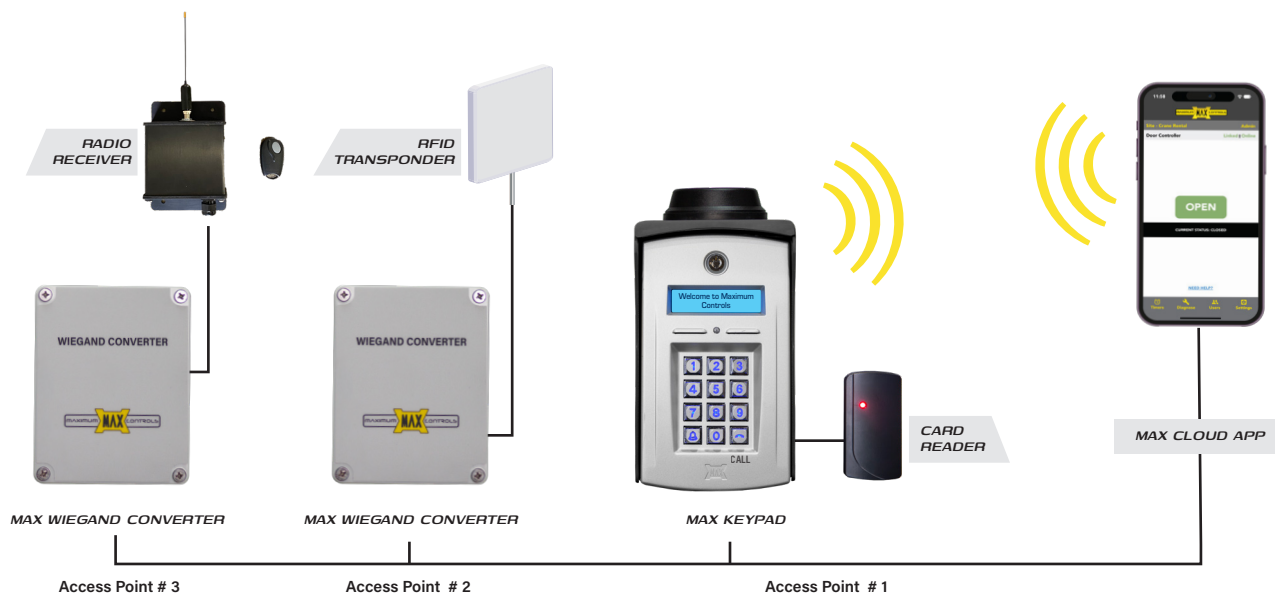

# MAX APP BASED KEYPAD

## RESIDENTIAL / COMMERCIAL APPLICATION

### APP BASED CELL KEYPAD



### Key Features

-  **App Based Trackable Keypad**
-  **Affordable cell data plans (AT&T or Verizon)**
-  **16 Zone Control using Wiegand Converters**
-  **15 Wireless zone control (1 mile range / 900 MHz) (with wireless Wiegand Converters)**
- COMING SOON**  **Push Notification for "Call" button pressed or Visitor Motion Detected**
-  **Guest Pass with date and time restriction**
-  **Event Log of all transactions**

